

Stella

SITS



Stella

UPHOLSTERY

COMFORTS

COVERS

SPECIAL



fabric



STD standard



LUX lux



CLS classic



FC fixed



LCV loose with velcro



modular system

All drawings shown height with leg no. 141A H-14.

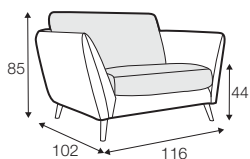

armchair

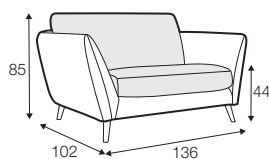

armchair wide

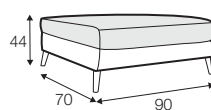

footstool 90x70

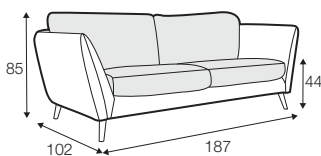

2 seater

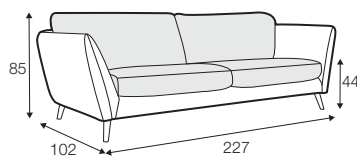

3 seater

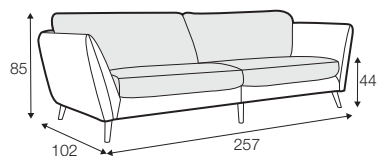

3XL seater (divided, two cushions)

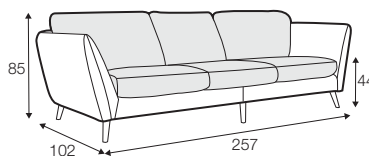

3XL seater (divided, three cushions)

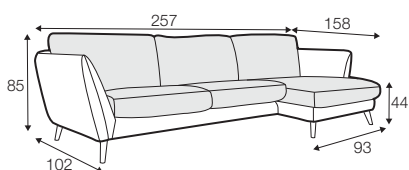

set 1 right / or left

2 seater left / or right
+ chaiselongue right / or left

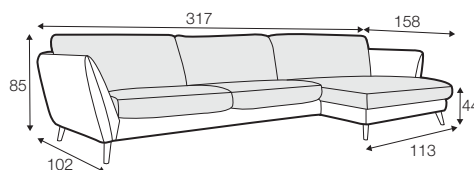

set 2 right / or left

3 seater left / or right
+ chaiselongue wide right / or left

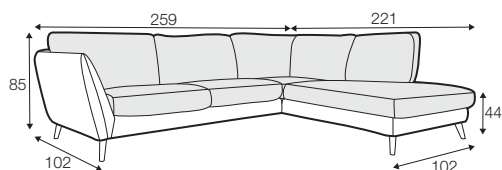

set 3 right / or left

2 seater left / or right + divan right / or left

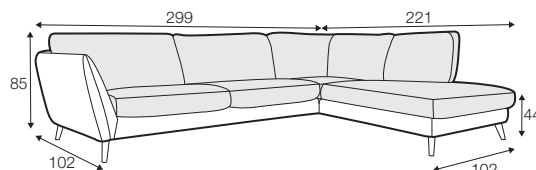

set 4 right / or left

3 seater left / or right + divan right / or left

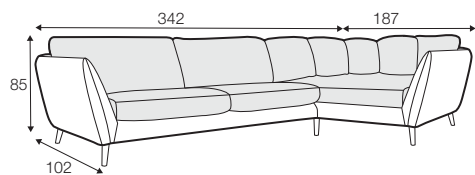

set 5 right / or left
3 seater left / or right + cozy corner right / or left

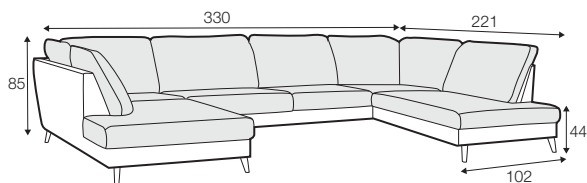

set 6
divan left + 2 seater without armrests + divan right

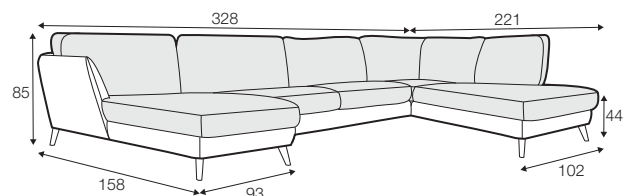

set 7 right / or left
chaiselongue left / or right + 2 seater without armrests
+ divan right / or left

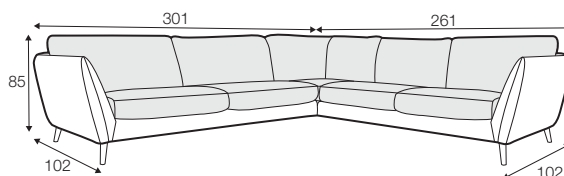

set 8 right / or left
3 seater left / or right + corner 90° no. 1 + 2 seater right / or left

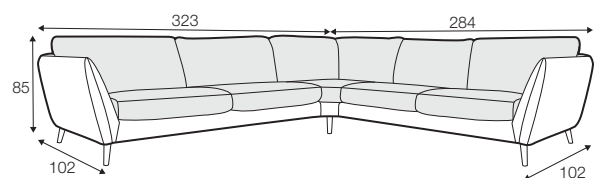

set 9 right / or left
3 seater left / or right + corner 90° no. 2
+ 2 seater right / or left

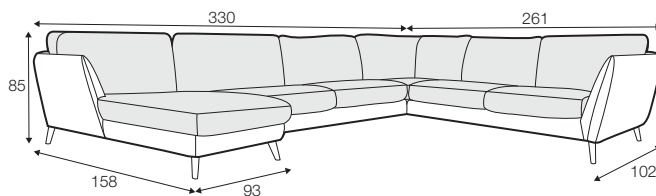

set 10 left / or right
chaiselongue left / or right + 2 seater without armrests
+ corner 90° no. 1 + 2 seater right / or left

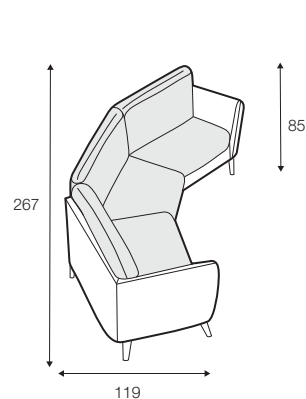

set 13
armchair left + corner 30°
+ armchair right

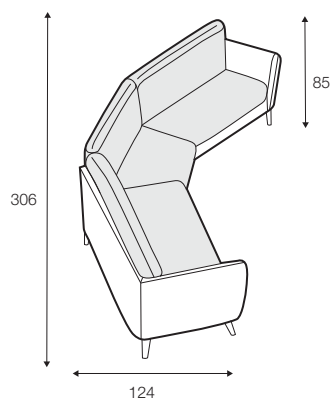

set 14
armchair wide left + corner 30°
+ armchair wide right

modular system

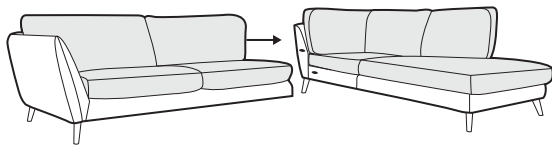

elements of the modular system

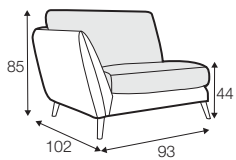

armchair left / or right

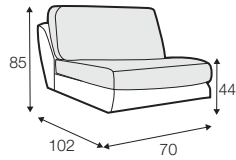

armchair
without armrests

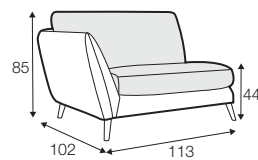

armchair wide left / or right

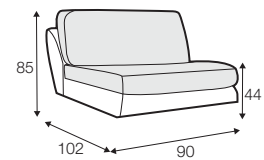

armchair wide
without armrests

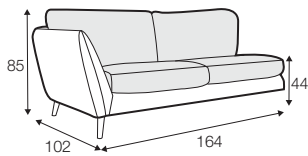

2 seater left / or right

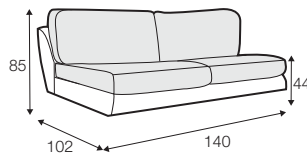

2 seater without armrests

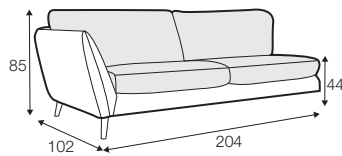

3 seater left / or right

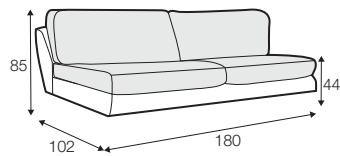

3 seater without armrests

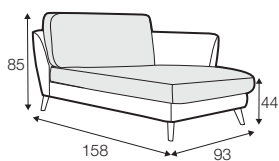

chaiselongue right / or left

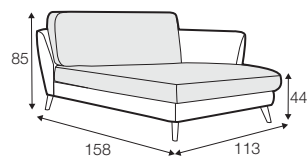

chaiselongue wide
right / or left

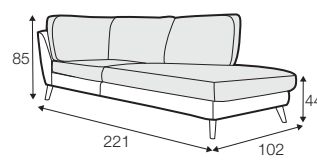

divan right / or left

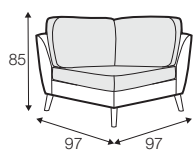

corner 90° no. 1

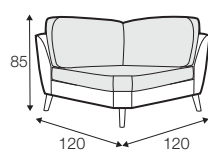

corner 90° no. 2

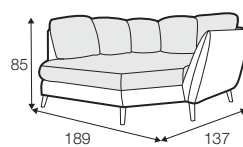

cozy corner right / or left

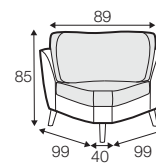

corner 30°

extra dimensions

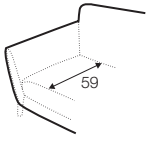

depth of seat

accessories

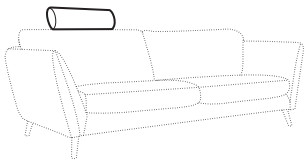

headrest L-62

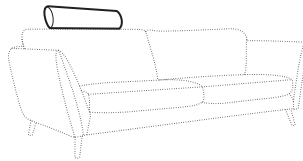
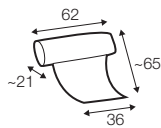

headrest L-77

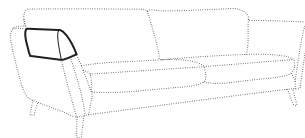
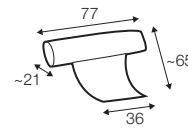

armrest protection

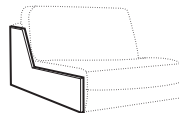

endpart left / or right

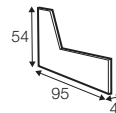

legs

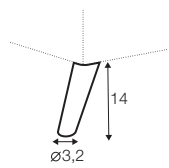

no. 141A
wood
recommended

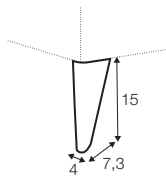

no. 91
wood

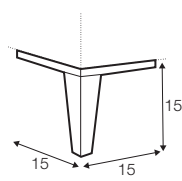

no. 152
wood

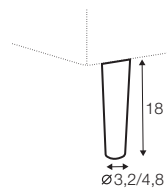

no. 141B
wood

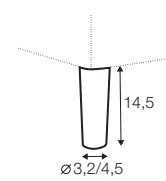

no. 153
wood

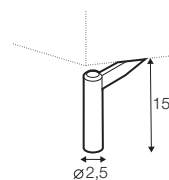

no. 145A
metal chrome,
painted black or grey
and brushed steel*

*please check a cost of brushed steel finish with a sale representative.

profile

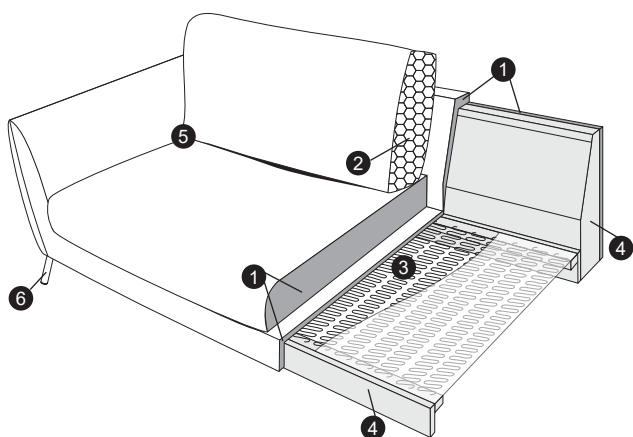

standard

1. polyurethane foam/high resilient polyurethane foam
2. silicone balls lux
3. springs
4. FSC® certified solid wood and wood based elements
5. fabric
6. FSC® certified solid wood or metal legs

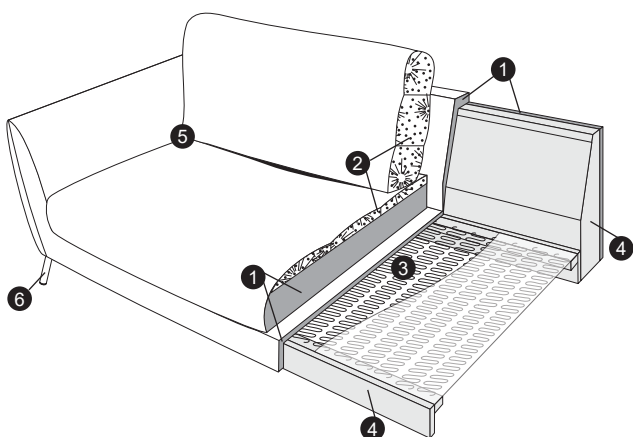

lux

1. polyurethane foam/ high resilient polyurethane foam
2. cushion chamber with mix of feather and silicone balls
3. springs
4. FSC® certified solid wood and wood based elements
5. fabric
6. FSC® certified solid wood or metal legs

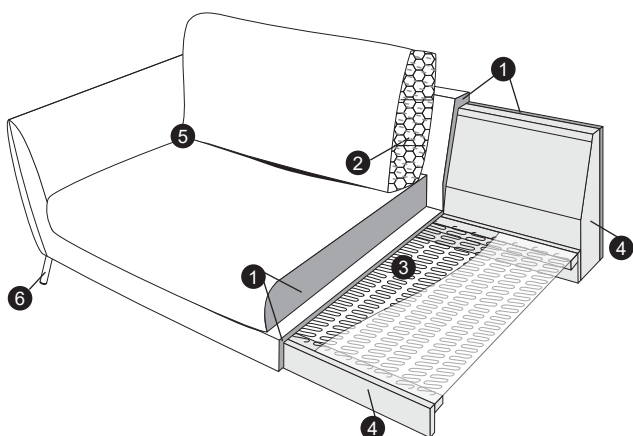

classic

1. polyurethane foam/high resilient polyurethane foam
2. silicone balls with foam sticks
3. springs
4. FSC® certified solid wood and wood based elements
5. fabric
6. FSC® certified solid wood or metal legs