

Quattro

SITS



Quattro

UPHOLSTERY



fabric



leather

COMFORTS



STD standard



LUX lux



CLS classic

COVERS



FC fixed

SPECIAL



sofa bed



modular system

Drawing show combinations with armrest 400. Combinantons with other armrest are properly longer or shorter in width.
Cushions can be in fix cover in 70/90 version.
Drawings shown height with leg no. 53 H-10.

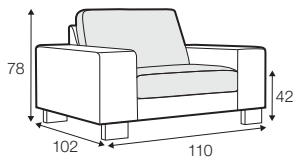

armchair 71

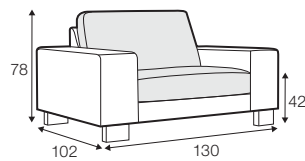

armchair 91

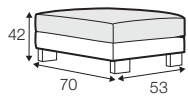

footstool 70x53
version 91x71

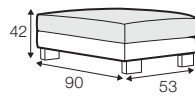

footstool 90x53
version 91x71

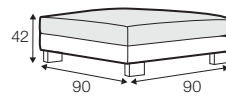

footstool 90x90
version 91x71

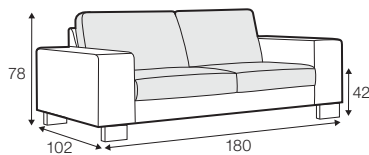

2 seater 71

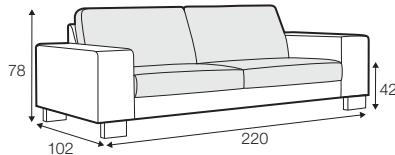

3 seater 91

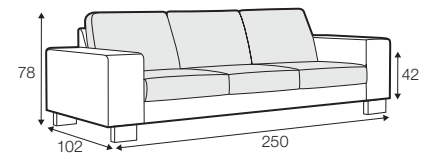

3 seater XL 71

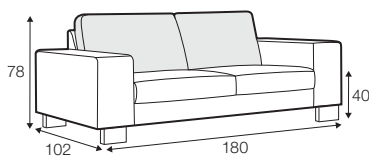

sofa bed

standard comfort - only version 70 for fabric and leather

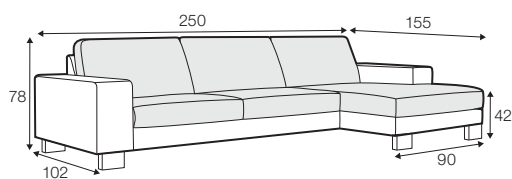
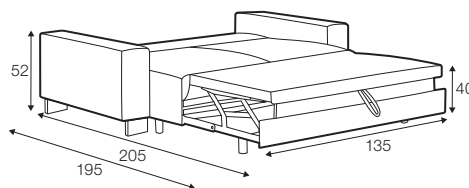

set 1 right / or left

2 seater 71 left / or right + chaiselongue 71 right / or left

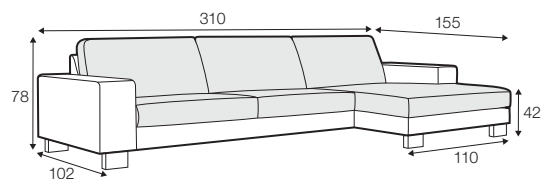

set 2 right / or left

3 seater 91 left / or right + chaiselongue 91 right / or left

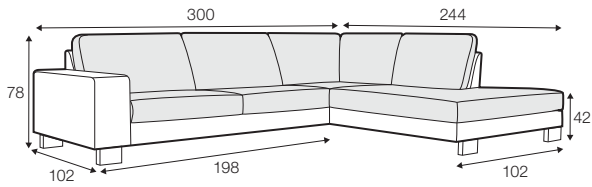

set 14 right / or left

3 seater 91 left / or right + corner 90° no. 320
+ bench 71 right / or left

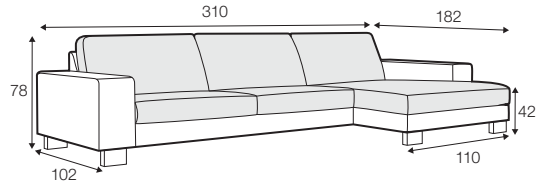

set 16 right / or left

3 seater 91 left / or right + chaiselongue 91 long right / or left

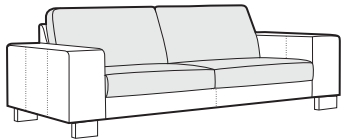

example of leather cover
3 seater 91

modular system

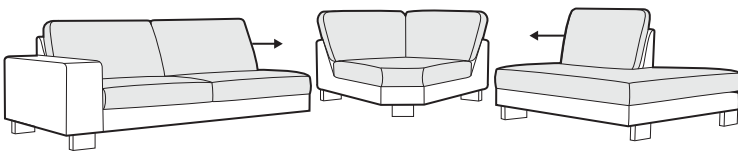

elements of the modular system

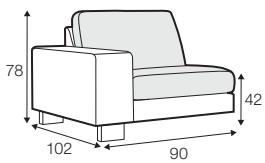

armchair 71
left / or right

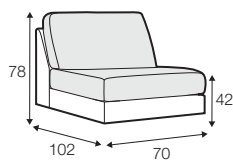

armchair 71
without armrests

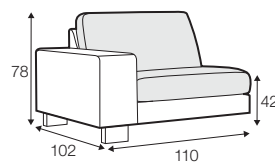

armchair 91
left / or right

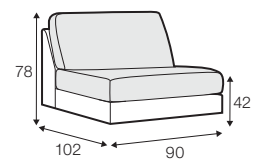

armchair 91
without armrests

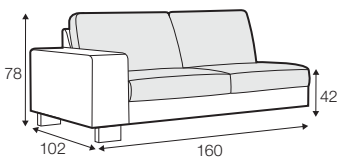

2 seater 71 left / or right

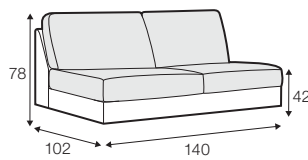

2 seater 71 without armrests

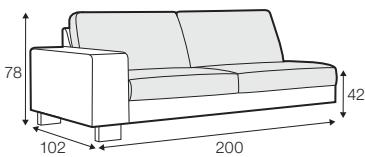

3 seater 91 left / or right

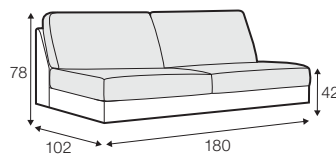

3 seater 91 without armrests

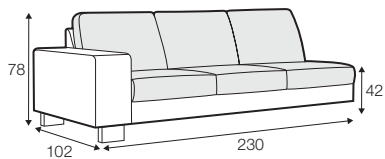

3 seater XL 71 left / or right

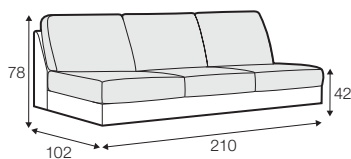

3 seater XL 71 without armrests

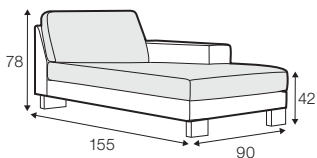

chaiselongue 71 right / or left

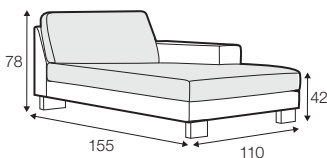

chaiselongue 91 right / or left

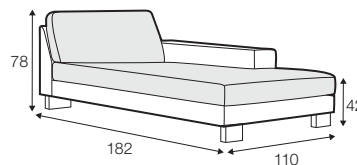

chaiselongue 91 long right / or left

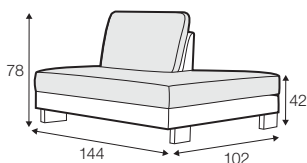

bench 71 right / or left

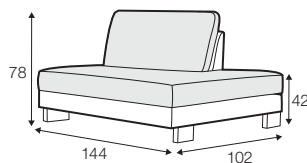

bench 91 right / or left

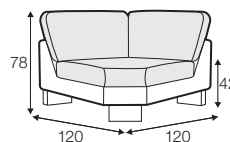

corner 90° no. 310

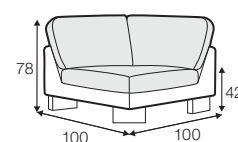

corner 90° no. 320

extra dimensions

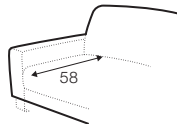

depth of seat

accessories

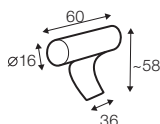
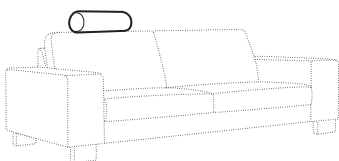

headrest with roll L-60
The headrest is available only in
STANDARD/CLASSIC comfort

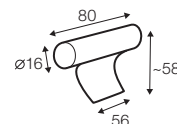
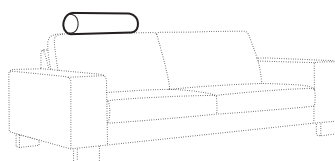

headrest with roll L-80
The headrest is available only in
STANDARD/CLASSIC comfort

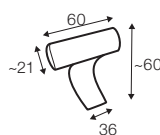
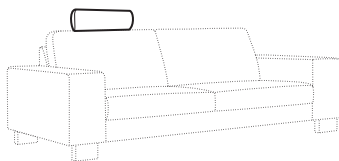

headrest L-60
The headrest is available in
LUX & STANDARD/CLASSIC comfort

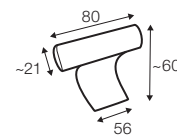
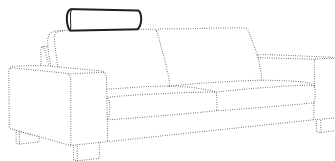

headrest L-80
The headrest is available in
LUX & STANDARD/CLASSIC comfort

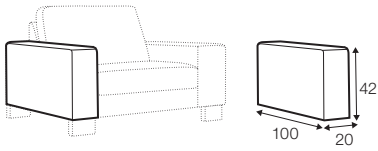

armrest 400

100x20x42

available with feet:

no. 47, no. 51, no. 53, no. 61A, no. 145A ,no. 176

legs to SB H-100:

all above

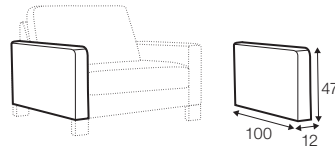

armrest 450

100x12x47

available with feet:

no. 47, no. 51, no. 53, no. 61A, no. 145B ,no. 176

legs to SB H-100:

no. 145B, no. 176

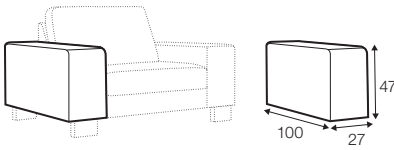

armrest 460

100x27x47

available with feet:

no. 47, no. 51, no. 53, no. 61, no. 145A ,no. 176

legs to SB H-100:

all above

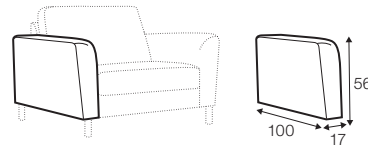

armrest 480

100x17x56

available with feet:

no. 47, no. 51, no. 53, no. 145B ,no. 176

legs to SB H-100:

no. 145B, no. 176

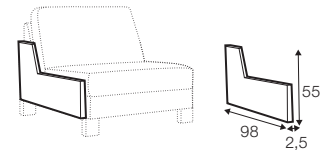

endpart left / or right

legs

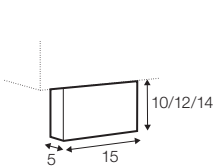

no. 51

wood

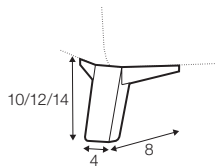

no. 176

wood

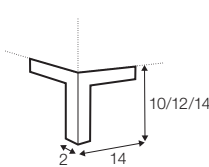

no. 47

metal chrome,
painted black or grey
and brushed steel*

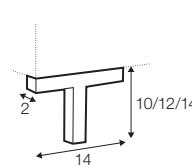

no. 47A

metal chrome,
painted black or grey
and brushed steel
(only for corners)*

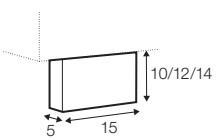

no. 53

metal chrome,
painted black or grey
and brushed steel*

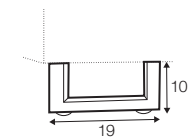

no. 61

metal chrome,
painted black or grey
and brushed steel*

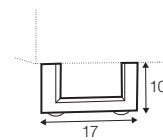

no. 61A

metal chrome,
painted black or grey
and brushed steel*

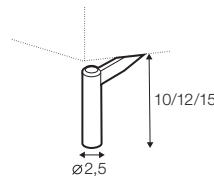

no. 145A

metal chrome,
painted black or grey
and brushed steel*

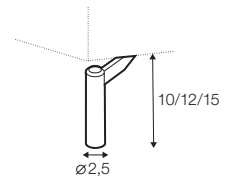

no. 145B

metal chrome,
painted black or grey
and brushed steel*

*please check a cost of brushed steel finish with a sale representative

profile

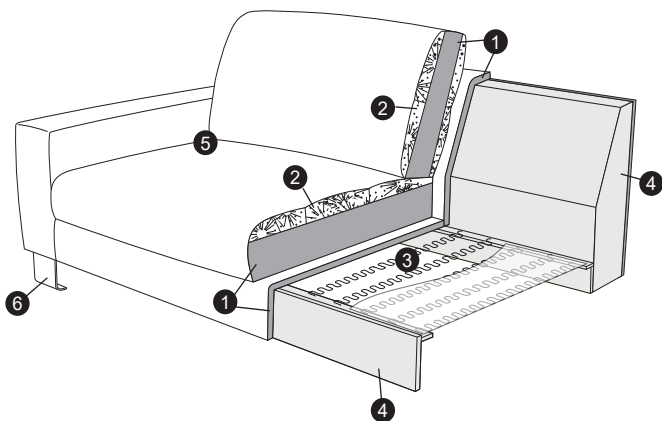

lux

1. polyurethane foam/ high resilient polyurethane foam
2. cushion chamber with mix of feather and silicone balls
3. springs
4. solid wood and wood based elements
5. fabric or leather
6. solid wood or metal legs

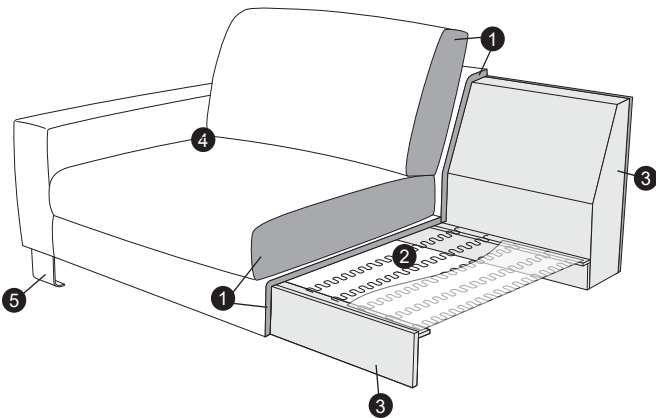

standard

1. polyurethane foam/ high resilient polyurethane foam
2. springs
3. solid wood and wood based elements
4. fabric or leather
5. solid wood or metal legs

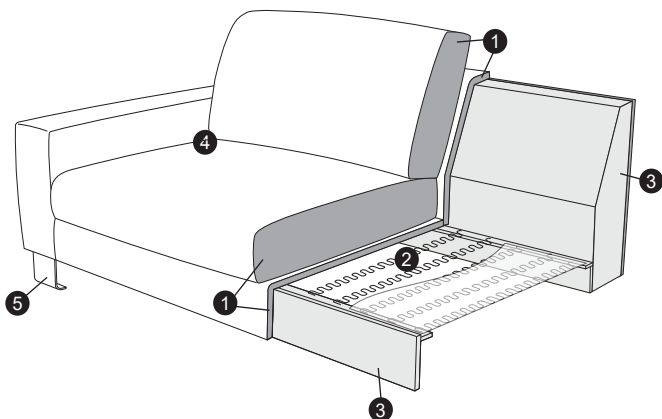

classic

1. polyurethane foam/ high resilient polyurethane foam
2. springs
3. solid wood and wood based elements
4. fabric or leather
5. solid wood or metal legs